

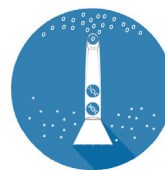

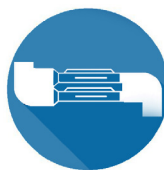

CLEAN AIR MAKES THE DIFFERENCE

Corona-Proof Buildings



VIROBUSTER
THE AIR PURIFICATION SPECIALIST



„Virobuster can provide a valuable contribution to reduce an infection significantly“

Dr. Ron Hendrix, Dutch NOS news, 26 Mai 2008



INTRODUCTION

The corona virus spreads through

- > Direct (droplet) contact
- > Inhaling aerosols
- > Smear infections
- > HVAC (recirculation) risk

The discipline actions are:

- > Keep 1.5 m distance at work place
- > Wear a mask if walking around or meeting colleagues
- > Use regular hand sanitizers and wipes for surface cleaning
- > Check & protocol regular the body temperature

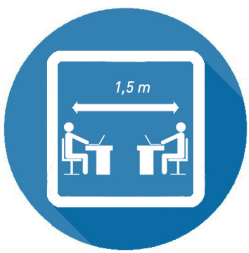

The HVAC actions are:

- > Increase ventilation rates
- > Increase humidity
- > Alter virus spreading overhead systems into (post) downflow systems
- > If no HVAC available, use the Steribase 300 to create downflow & inactivation

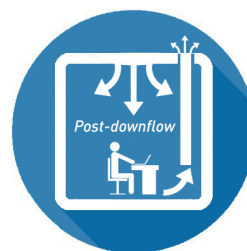
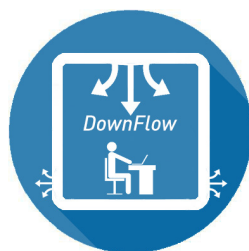
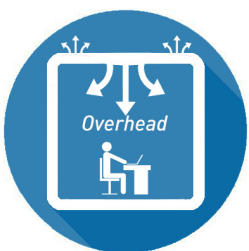



“The air is the only thing left dirty, and these opportunities give us a chance to also optimize these last aspects also”

Dr. Marc Eijnsink, - Dutch NOS news, 26 Mai 2008

NO ACTION - VIRUS SPREAD

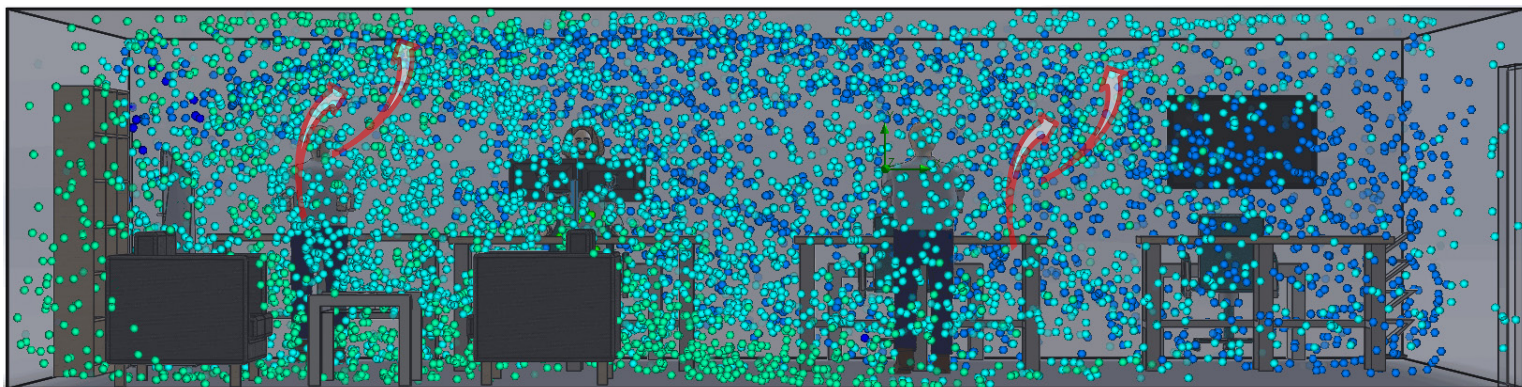

STERIBASE 300 IN ACTION - ALMOST NO VIRUS SPREAD

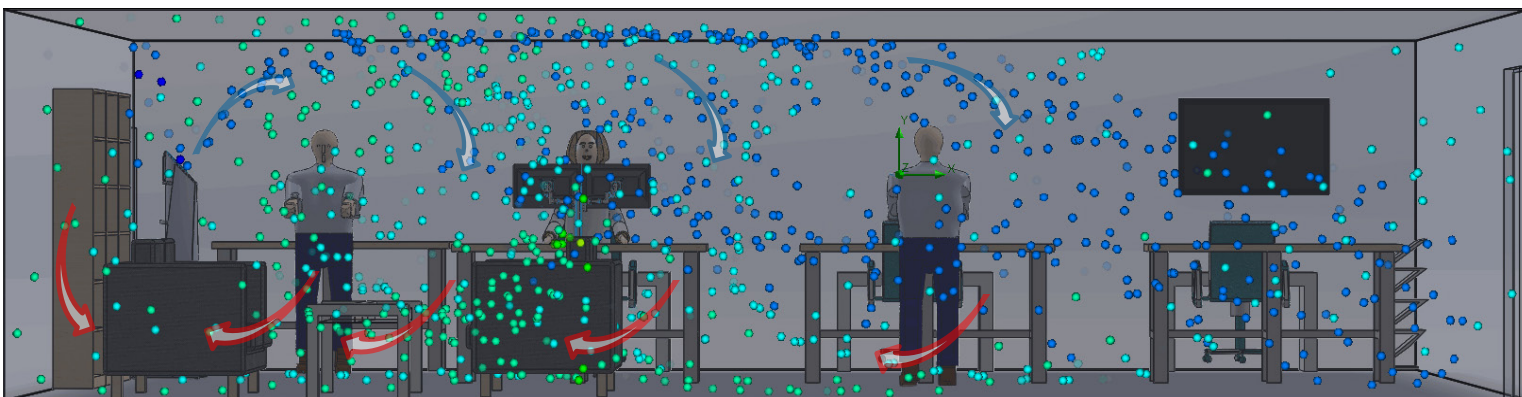

REASONS TO CHOOSE VIROBUSTER

> SUSTAINABLE

Lasting solution for making a building corona-proof

> EFFICIENT

Proven >99,99% kill for the corona virus

> EASY APPLICATION

Modular and « Plug & play » solution

> ECOLOGICAL

No use of chemicals, no organic waste, no ozone production

> ECONOMIC BENEFIT

No need for customized manufacture and upgrading existing HVAC systems

CLEAN AIR MAKES THE DIFFERENCE

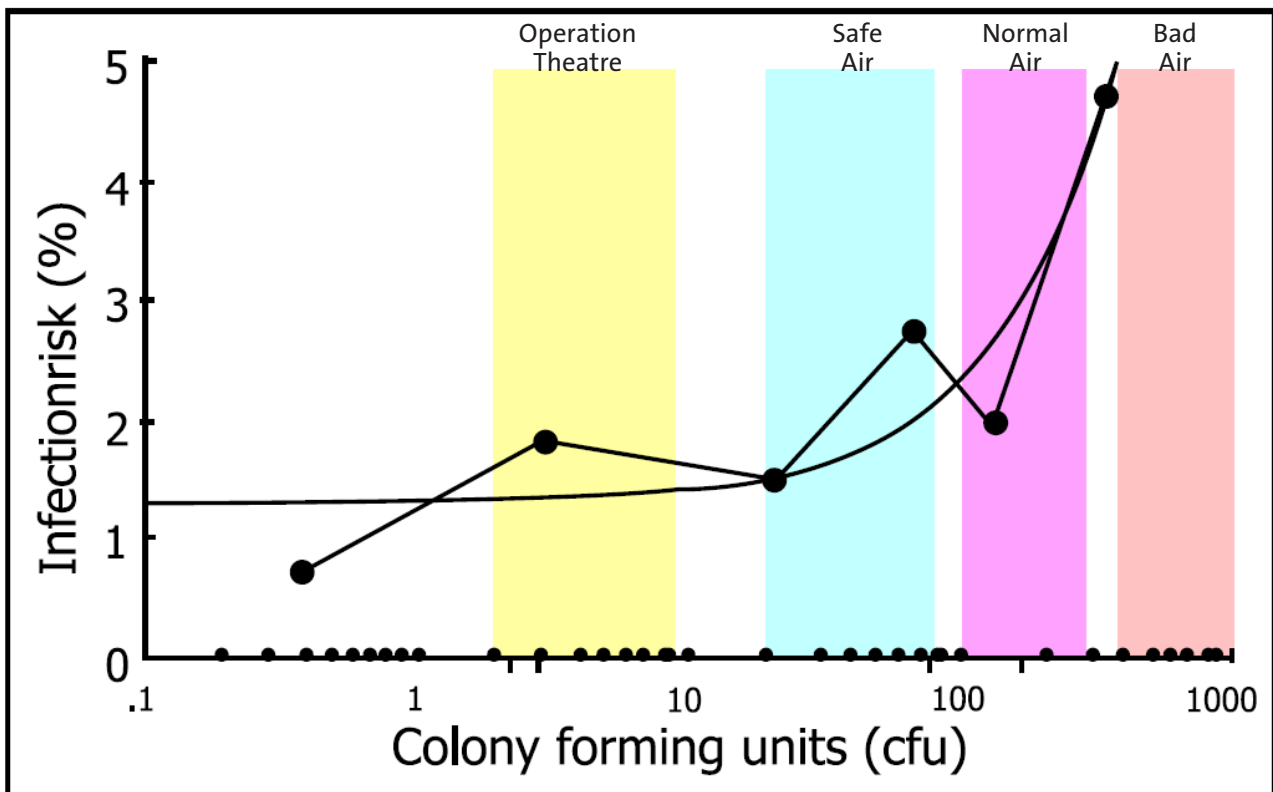



*STOP the micro organism reproduction
NEUTRALIZES their damage potential*

HOW DOES IT WORK

- > DNA is blocked by UVC (254nm)
- > Cell division of the virus is prevented
- > An infection is prevented



Viruses, Bacteria & Moulds with infection potential

Cell division will be prevented

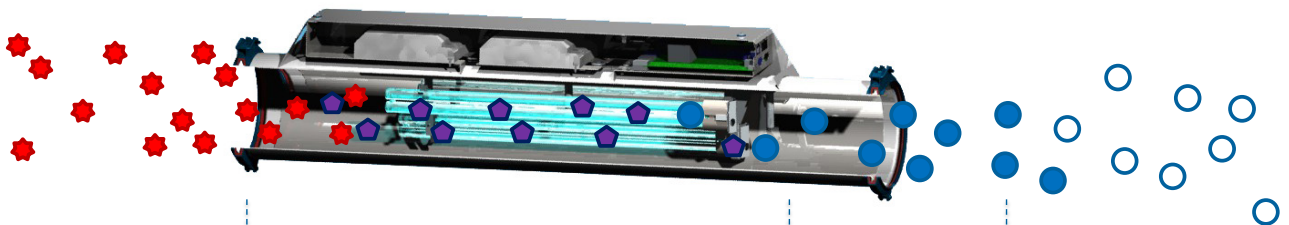

UV-C blocks the DNA

No more infection risk

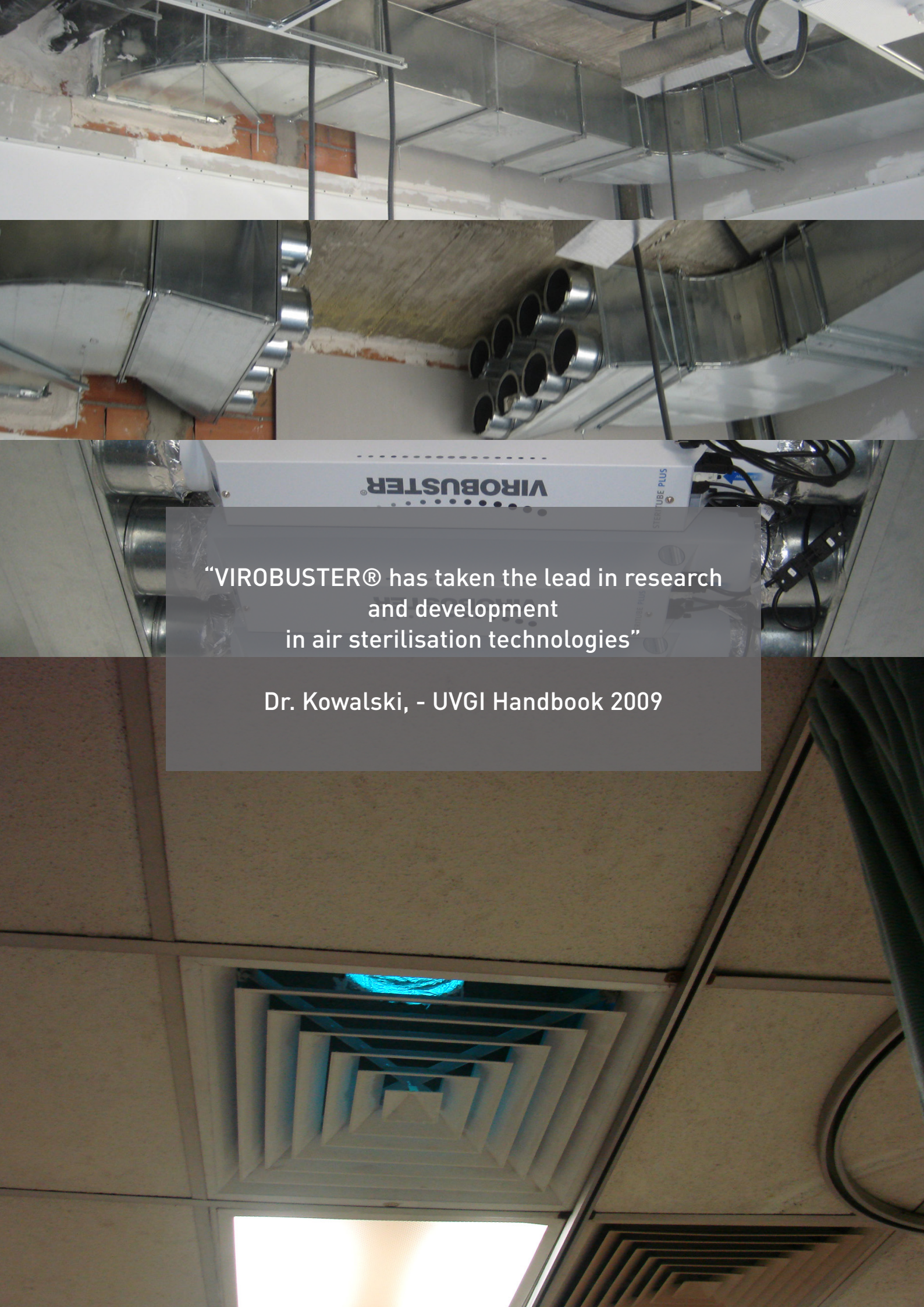

“VIROBUSTER® has taken the lead in research
and development
in air sterilisation technologies”

Dr. Kowalski, - UVGI Handbook 2009

USE IN PRACTICE

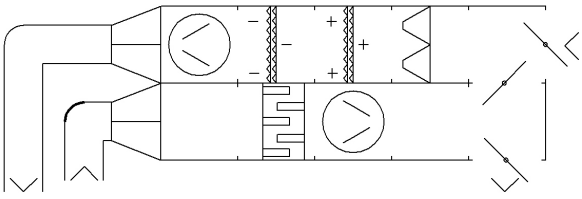

Old systems with direct air recirculation

The old systems do have the advantage that the humidity can be reused directly also and that the heat recovery efficiency is maximal.

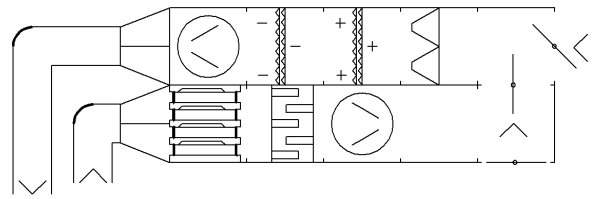

Upgrade into Corona-Proof AHU:

The Steritubes are positioned in the return to create virus-free air before mixing with the fresh air.

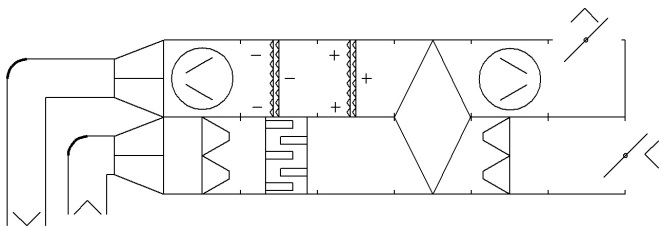

Heat Recovery systems (wheel or plates)

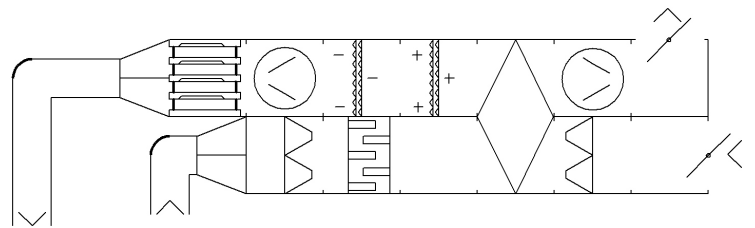

Upgrade into Corona-Proof AHU:

The Steritubes are positioned in the supply to create virus-free air when a heat wheel is used.

Implementation options

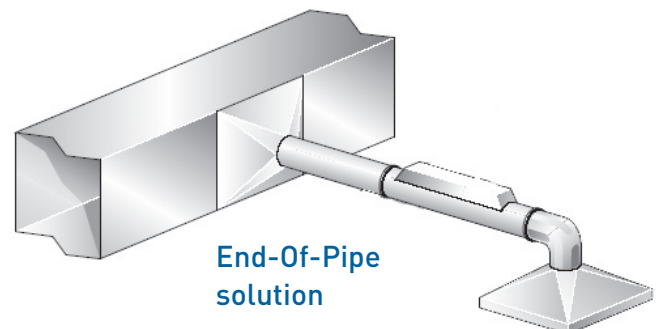
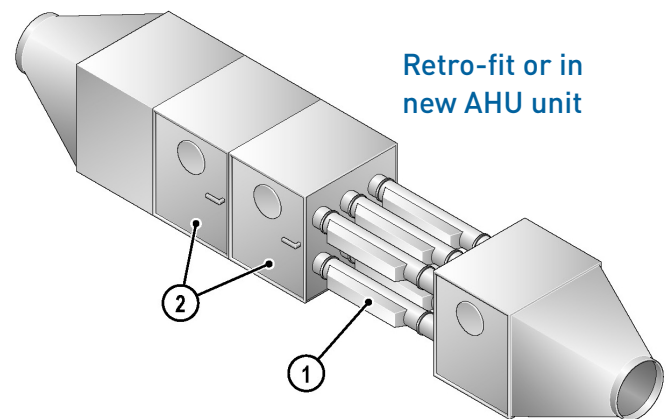
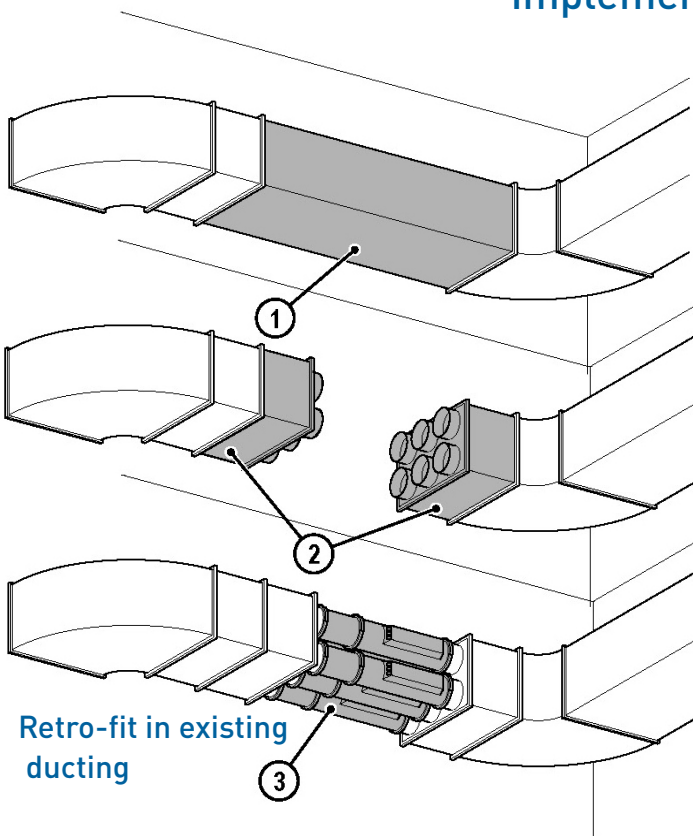



VIROBUSTER® is a Born Global Firm”

Dr. Paula Englis, - “Born Global Firms” 2011



CASES

Waiting rooms are often areas where there is a high germ content. Here, our mobile devices such as the Steribase 300 PLUS can be used to protect visitors, staff and patients.

ACHIEVED ADVANTAGES:

- > Improved safety for visitors & staff
- > Solution against viruses
- > Quick & easy installation



Steribase family



VIROBUSTER®
Steritube

VIROBUSTER® installed Steritubes in the HVAC system of several beauty centres.

ACHIEVED ADVANTAGES:

- > Improved safety for visitors & employees
- > Psychologic effect of being protected
- > Clean air request on-demand



“Buildings become more and more isolated, resulting in air related problems. UVGI is an upcoming technology dealing with this”

Prof. Andre Doree



CASES



**VIROBUSTER®
Steritube**

The air supply for an office have been executed with 9 Steritubes, providing virus free air to the department.

ACHIEVED ADVANTAGES:

- > No risk from outside
- > Real increased safety
- > Energy savings, by using the return air and humidity

A marketing company was forced to work home, but after implementing all statet actions, the building became the certificate „co-rona-proof“.

ACHIEVED ADVANTAGES:

- > From dangerous overhead into (post) downflow
- > Easy solution by means of industrial-look piping
- > This reterun air is sterilized by Steritubes inside the AHU

ABOUT THE COMPANY

Virobuster International GmbH

Virobuster have been confirmed to be very effective and practical in the medical market

Many scientific publications, recommendation letters and press articles have been published which makes the Virobuster UVPE the first worldwide Evidence Based UV Technology.

The company established cooperation's with several partners in all interesting market segments to meet the worldwide request.

- > Scientific proven
- > Worldwide accepted
- > Standard product

Position & calculation advice

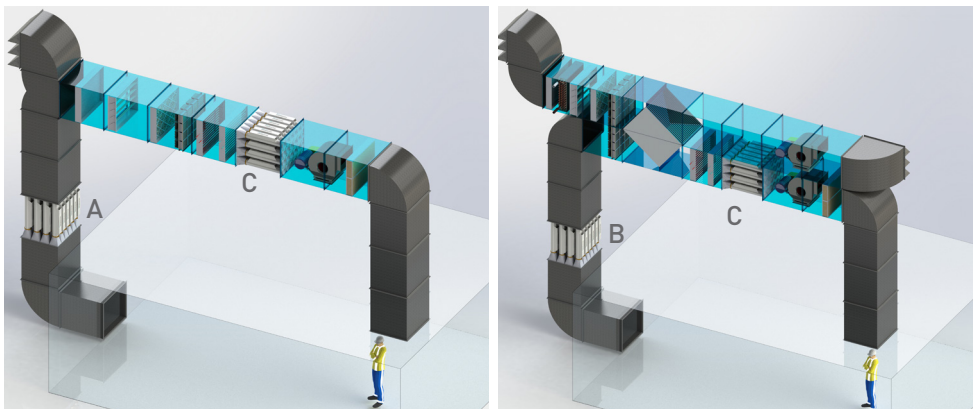

Physical heat & humidity recovery

(Heat) energy recovery

The options to fit in the Steritubes are:

- > In the physical heat & humidity recovery **(A)**
- > In the heat energy recovery when a wheel is used to prevent the carry-over effect of the viruses **(B)**
- > In the direct air supply for both systems **(C)**

For fresh air inlet assume 500 m³/h and 800 m³/h per Steritube when fitted into the recirculated duct



“The importance of IAQ (Indoor Air Quality) - or in other words the possibility to transmit pathogenic materials by air, became widely known to the public and the authorities due to the worldwide Corona virus outbreak.



Corona - Proof

Average Air Changes per Hour (ACH) and minutes according to regulations		(av.) initial CFU	Minutes -90%
ACH	Description		
1	cold storage, warehouse, lockerroom,	250-500	138
2	Production hall	750 -1250	69
3	Indoor Swimmingpool (VDI 2089)	250 - 500	46
4	conference room, library, Gym (DIN 1946-2)	125 -250	35
5	Shopping mall & Retail stores (VDI 2082)	250 -500	28
6	Classroom (DIN 1946-2), Isolation room (DIN 1946-1)	250 -500	23
7	Theatre, Cinema, churches (DIN 1946-2)	250 - 500	20
8	Open plan office (DIN 1946-1)	125 - 250	17
9	Laboratories (VDI 2051)	100 - 250	15
10	Restaurants (DIN 1946-1), Casino (VDI 2082)	250 - 500	14
11	Minor surgery room (DIN 1946-1)	100 - 250	13
12	Intensive Care (DIN 1946-1)	10 - 100	12
13			11
14			10
15	Professional Kitchen (VDI 2052)	500 -750	9
16	Bars (DIN 1946-1)	250 - 500	9
17			8
18	Operation Theatre (DIN 1946-1)	<10	8

These values are averages and according to the mentioned regulations they can vary +2/-2 depending on the environmental conditions, etc.

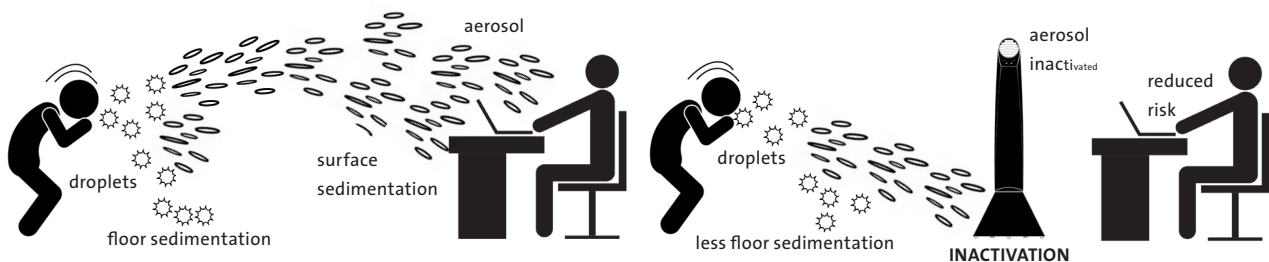

VIROBUSTER® INTERNATIONAL GmbH • Köhlershohner Straße 60 • DE-53578, Windhagen
 Tel +49-(0)2224-818-780 • info@virobuster.com • www.virobuster.com

